

Typ

## PB 2525-049

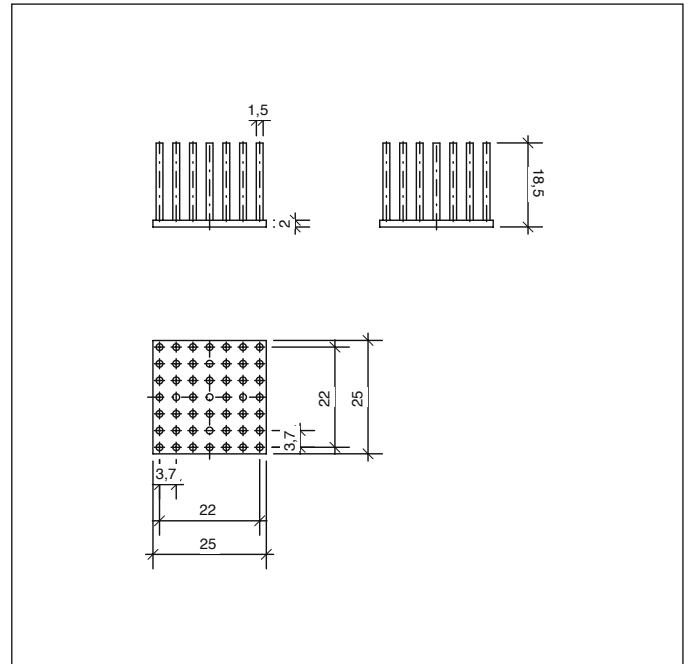
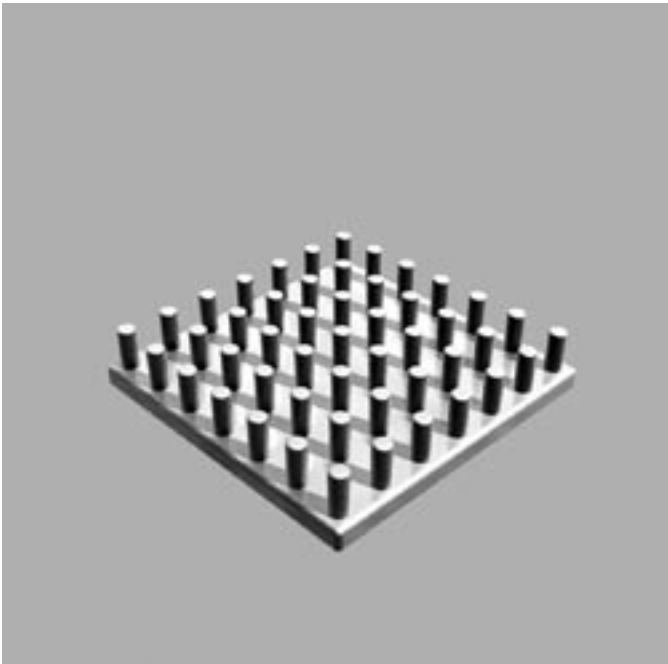

Artikelnummer	Länge in mm	Breite in mm	Gesamthöhe in mm	Stifthöhe in mm	Bodenstärke in mm	Stift-Ø in mm	Stiftanzahl	Material (DIN EN)
Part No.	length in mm	width in mm	total height in mm	pin height in mm	base plate in mm	pin-Ø in mm	pin number	material (DIN EN)
PB 2525-049-06,5	25	25	6,5	4,5	2,0	1,5	49	1050
PB 2525-049-10,0	25	25	10,0	8,0	2,0	1,5	49	1050
PB 2525-049-12,5	25	25	12,5	10,5	2,0	1,5	49	1050
PB 2525-049-18,5	25	25	18,5	16,5	2,0	1,5	49	1050

Thermische Daten / thermal data

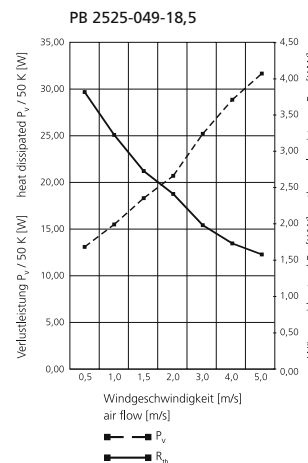
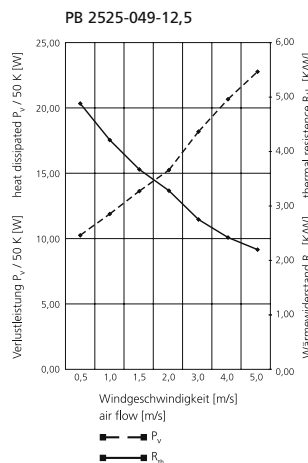
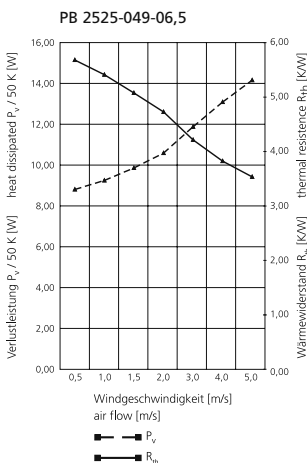

Typ

## PB 2929-064

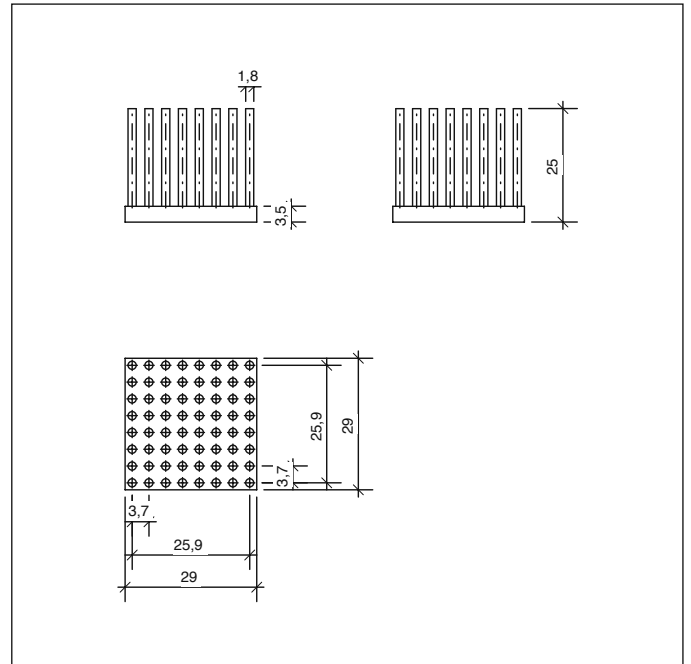
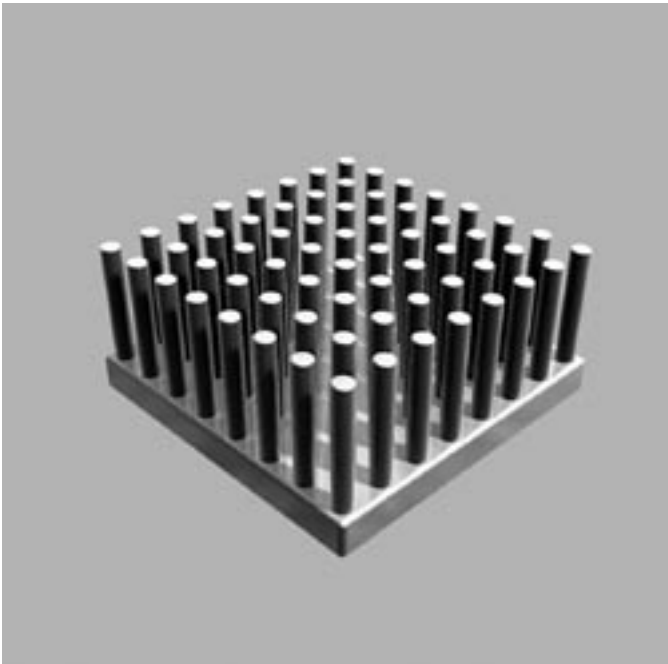

Artikelnummer	Länge in mm	Breite in mm	Gesamthöhe in mm	Stifthöhe in mm	Bodenstärke in mm	Stift-Ø in mm	Stiftanzahl	Material (DIN EN)
Part No.	length in mm	width in mm	total height in mm	pin height in mm	base plate in mm	pin-Ø in mm	pin number	material (DIN EN)
PB 2929-064-10	29	29	10	6,5	3,5	1,8	64	1050
PB 2929-064-15	29	29	15	11,5	3,5	1,8	64	1050
PB 2929-064-20	29	29	20	16,5	3,5	1,8	64	1050
PB 2929-064-25	29	29	25	21,5	3,5	1,8	64	1050

Thermische Daten / thermal data

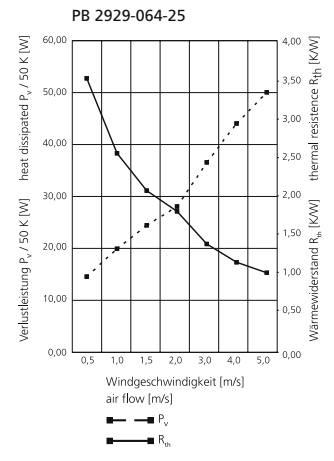
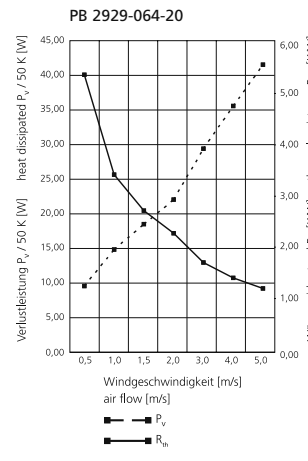
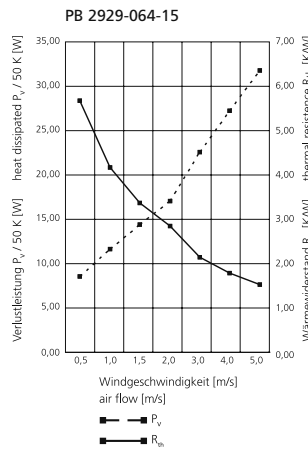
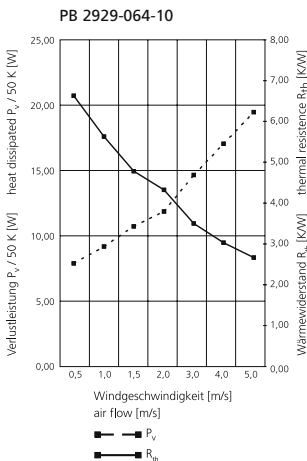

Typ

## PB 3232-081

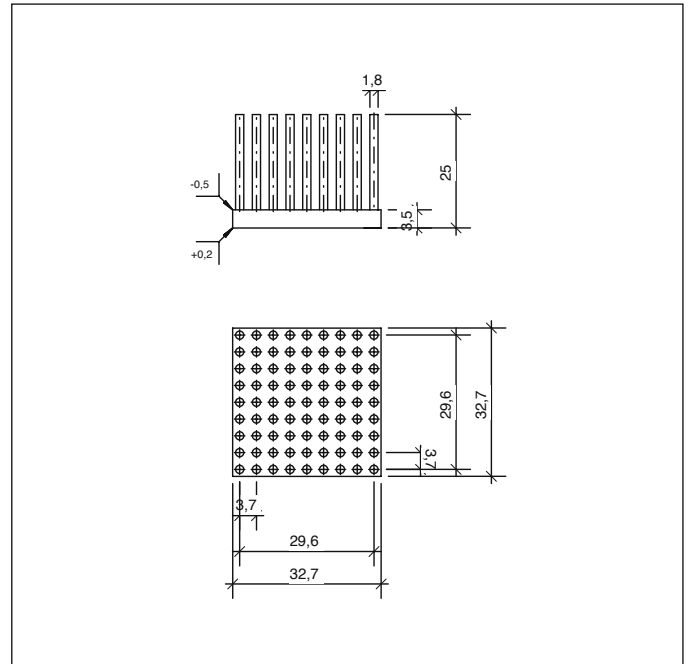
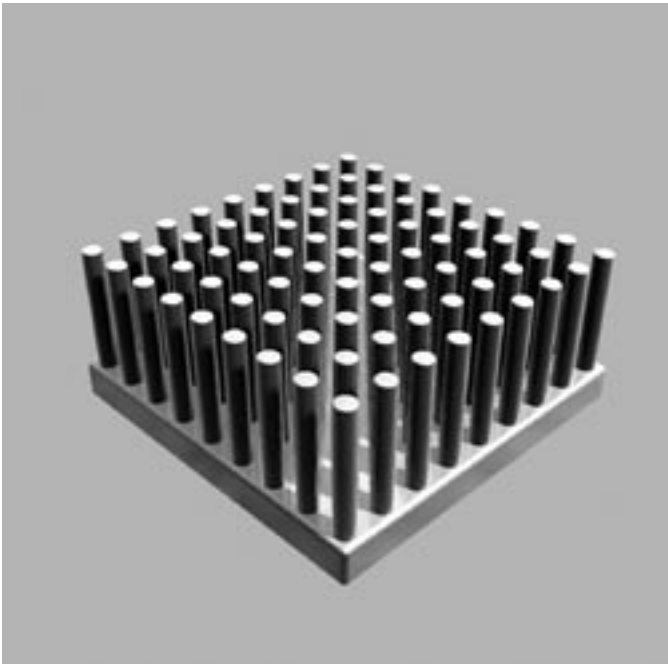

Artikelnummer	Länge in mm	Breite in mm	Gesamthöhe in mm	Stifthöhe in mm	Bodenstärke in mm	Stift-Ø in mm	Stiftanzahl	Material (DIN EN)
Part No.	length in mm	width in mm	total height in mm	pin height in mm	base plate in mm	pin-Ø in mm	pin number	material (DIN EN)
PB 3232-081-10	32,7	32,7	10	6,5	3,5	1,8	81	1050
PB 3232-081-15	32,7	32,7	15	11,5	3,5	1,8	81	1050
PB 3232-081-20	32,7	32,7	20	16,5	3,5	1,8	81	1050
PB 3232-081-25	32,7	32,7	25	21,5	3,5	1,8	81	1050

Thermische Daten / thermal data

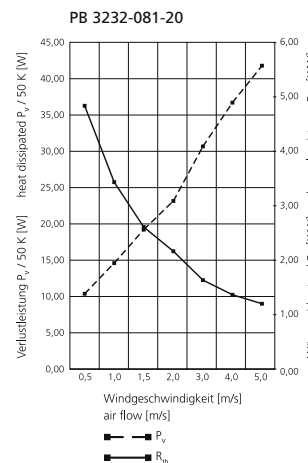
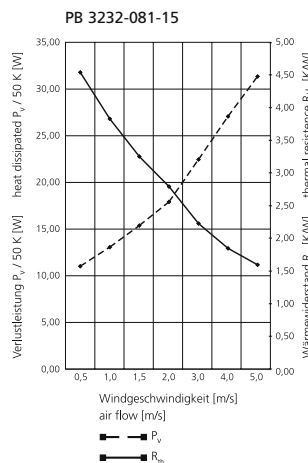
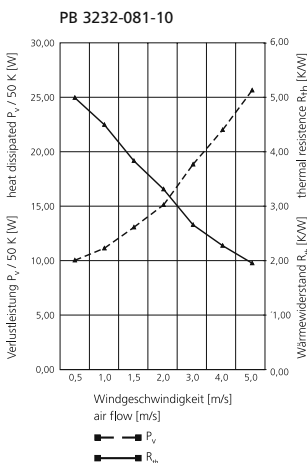

Typ

## PB 3636-100

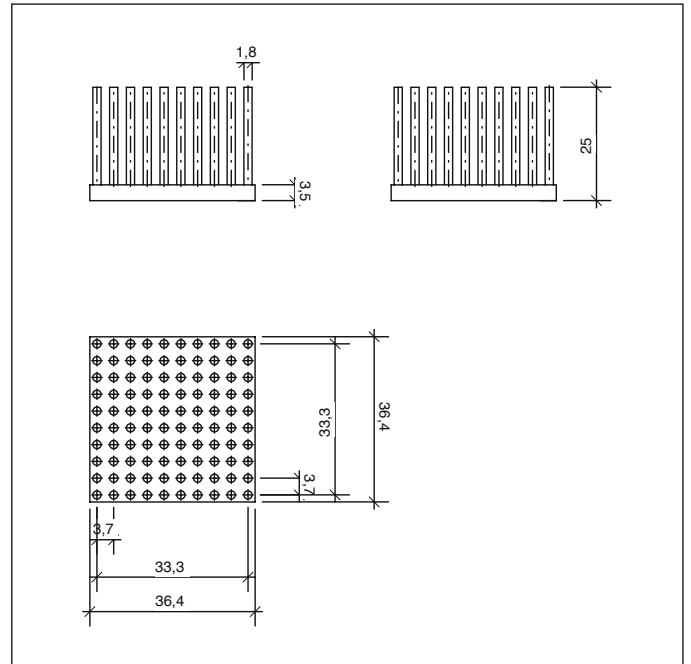
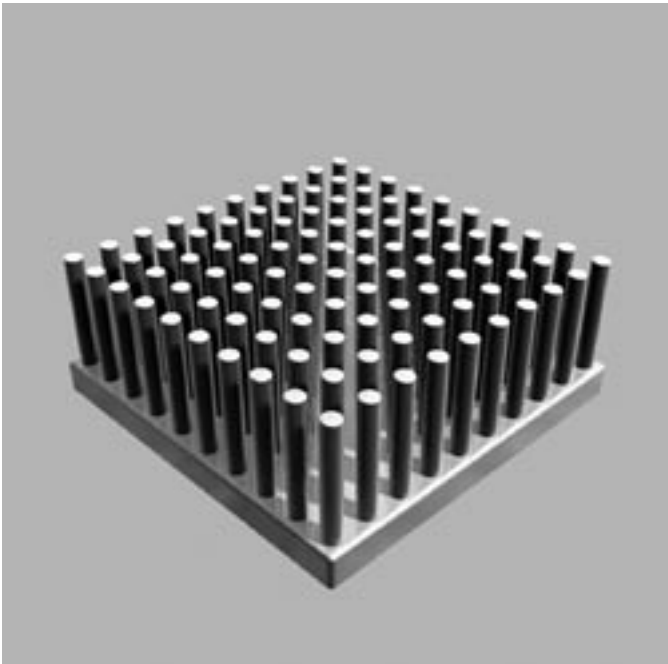

Artikelnummer	Länge in mm	Breite in mm	Gesamthöhe in mm	Stifthöhe in mm	Bodenstärke in mm	Stift-Ø in mm	Stiftanzahl	Material (DIN EN)
Part No.	length in mm	width in mm	total height in mm	pin height in mm	base plate in mm	pin-Ø in mm	pin number	material (DIN EN)
PB 3636-100-10	36,4	36,4	10	6,5	3,5	1,8	100	1050
PB 3636-100-15	36,4	36,4	15	11,5	3,5	1,8	100	1050
PB 3636-100-20	36,4	36,4	20	16,5	3,5	1,8	100	1050
PB 3636-100-25	36,4	36,4	25	21,5	3,5	1,8	100	1050

Thermische Daten / thermal data

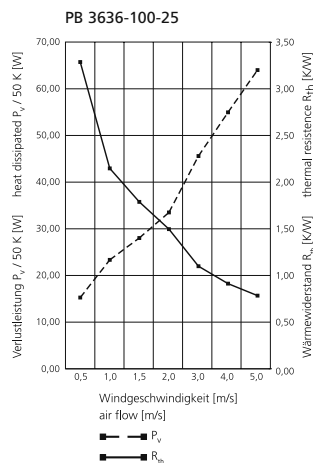
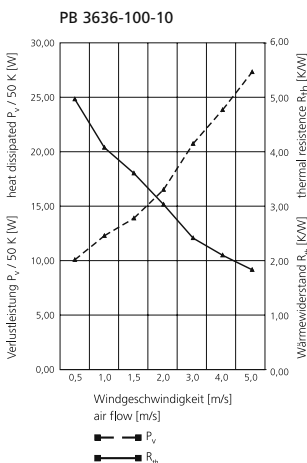

Typ

## PB 4040-121

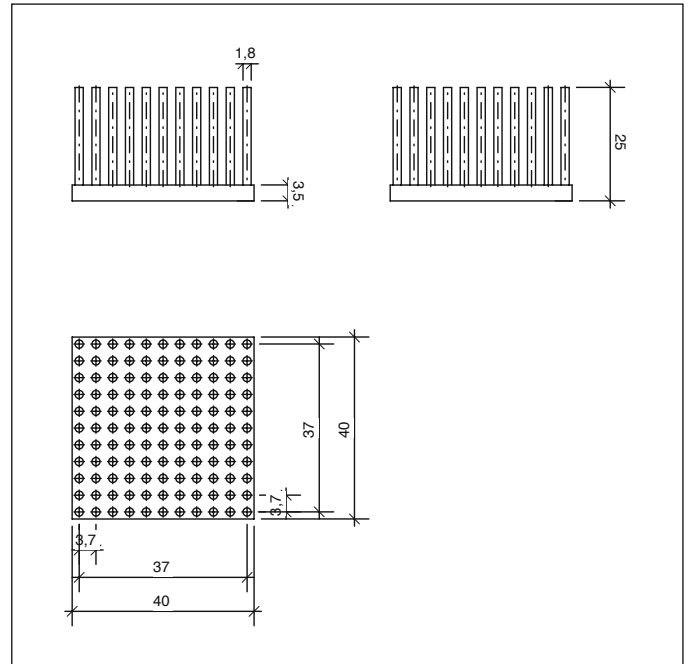
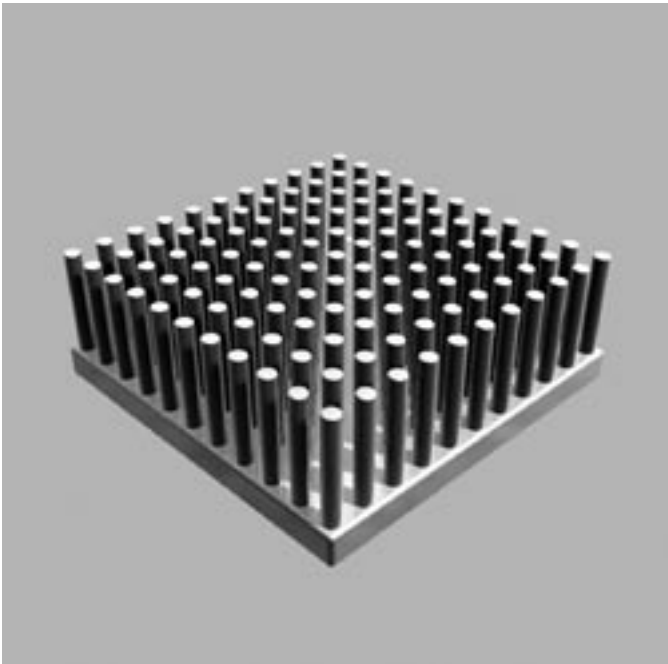

Artikelnummer	Länge in mm	Breite in mm	Gesamthöhe in mm	Stifthöhe in mm	Bodenstärke in mm	Stift-Ø in mm	Stiftanzahl	Material (DIN EN)
Part No.	length in mm	width in mm	total height in mm	pin height in mm	base plate in mm	pin-Ø in mm	pin number	material (DIN EN)
PB 4040-121-10	40	40	10	6,5	3,5	1,8	121	1050
PB 4040-121-15	40	40	15	11,5	3,5	1,8	121	1050
PB 4040-121-20	40	40	20	16,5	3,5	1,8	121	1050
PB 4040-121-25	40	40	25	21,5	3,5	1,8	121	1050

Thermische Daten / thermal data

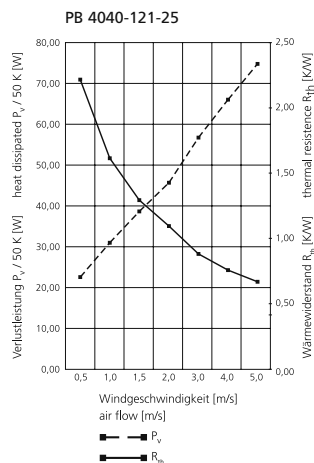
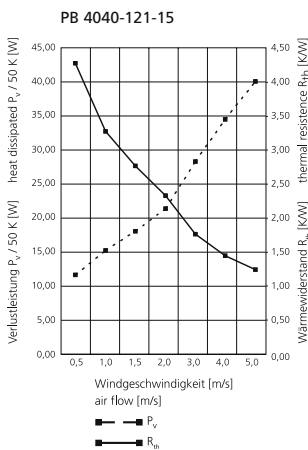

Typ

## PB 4545-144

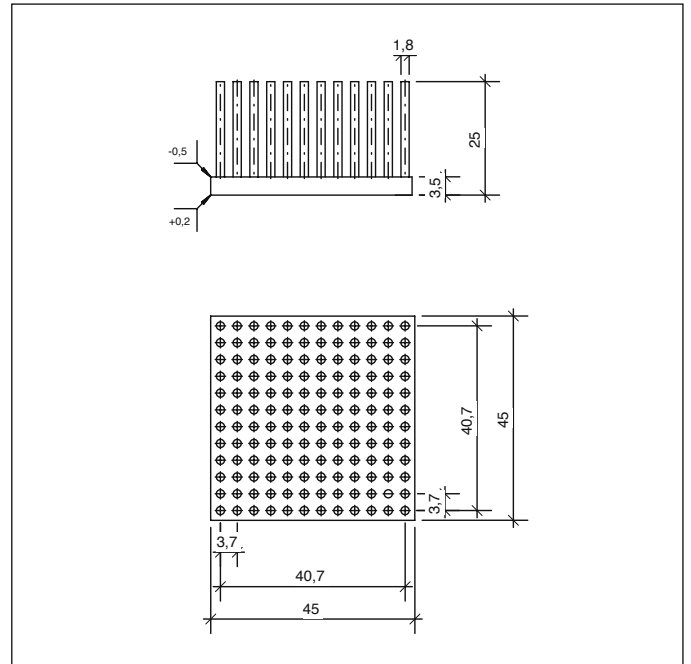
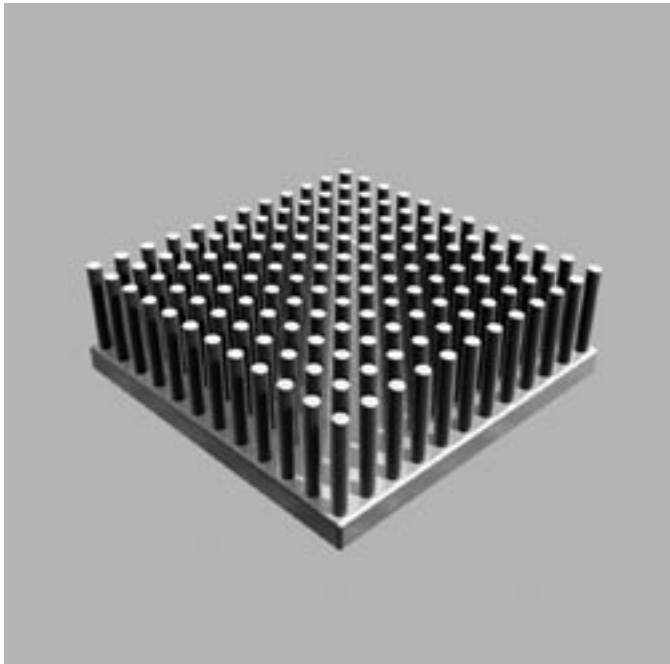

Artikelnummer	Länge	Breite	Gesamthöhe	Stifthöhe	Bodenstärke	Stift-Ø	Stiftanzahl	Material
	in mm	in mm	in mm	in mm	in mm	in mm		(DIN EN)
Part No.	length	width	total height	pin height	base plate	pin-Ø	pin number	material
	in mm	in mm	in mm	in mm	in mm	in mm		(DIN EN)
PB 4545-144-10	45	45	10	6,5	3,5	1,8	144	1050
PB 4545-144-15	45	45	15	11,5	3,5	1,8	144	1050
PB 4545-144-20	45	45	20	16,5	3,5	1,8	144	1050
PB 4545-144-25	45	45	25	21,5	3,5	1,8	144	1050

Thermische Daten / thermal data

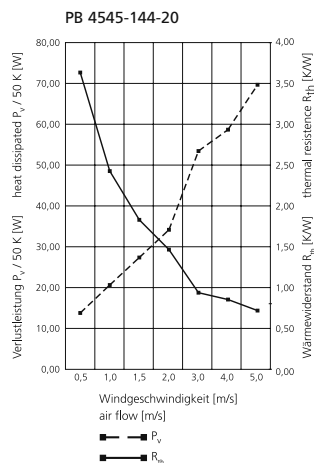
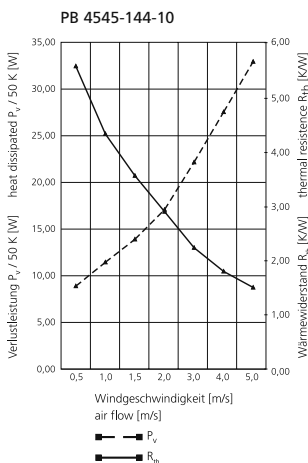

Typ

## PB 5050-169

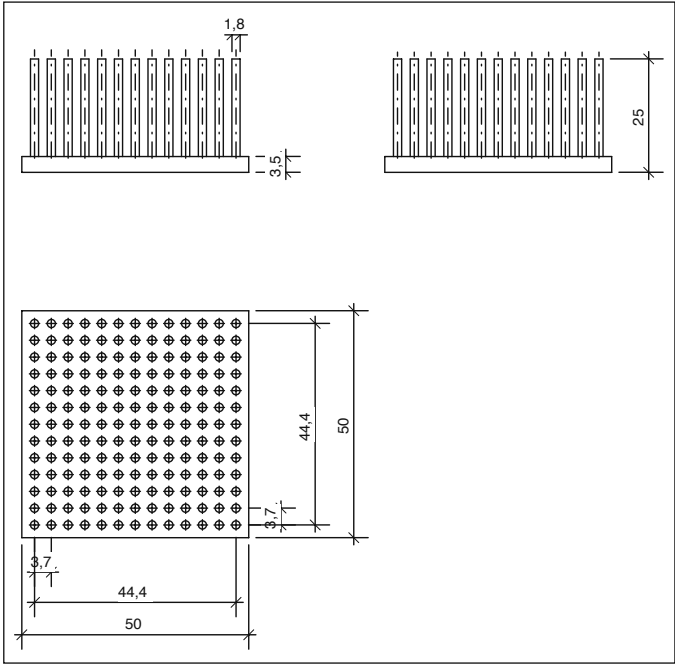
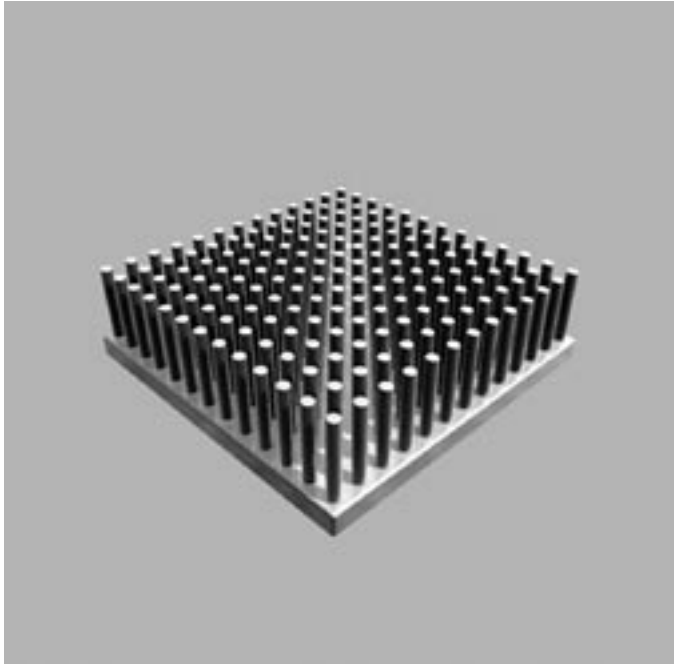

Artikelnummer	Länge	Breite	Gesamthöhe	Stifthöhe	Bodenstärke	Stift-Ø	Stiftanzahl	Material
Part No.	length	width	total height	pin height	base plate	pin-Ø	pin number	material
	in mm	in mm	in mm	in mm	in mm	in mm		(DIN EN)
PB 5050-169-10	50	50	10	6,5	3,5	1,8	169	1050
PB 5050-169-15	50	50	15	11,5	3,5	1,8	169	1050
PB 5050-169-20	50	50	20	16,5	3,5	1,8	169	1050
PB 5050-169-25	50	50	25	21,5	3,5	1,8	169	1050

Thermische Daten / thermal data

